

Acer Projector

K135/K135P/K135S/L221/LK-W12/
K132/L221F/LK-W12L Series
User's Guide

Copyright © 2013. Acer Incorporated.
All Rights Reserved.

Acer Projector K135/K135P/K135S/L221/LK-W12/K132/L221F/LK-W12L Series User's Guide
Original Issue: 02/2013

Changes may be made periodically to the information in this publication without obligation to notify any person of such revisions or changes. Such changes will be incorporated in new editions of this manual or supplementary documents and publications. This company makes no representations or warranties, either expressed or implied, with respect to the contents hereof and specifically disclaims the implied warranties of merchantability or fitness for a particular purpose.

Record the model number, serial number, purchase date and place of purchase information in the space provided below. The serial number and model number are recorded on the label affixed to your projector. All correspondence concerning your unit should include the serial number, model number and purchase information.

No part of this publication may be reproduced, stored in a retrieval system, or transmitted, in any form or by any means, electronically, mechanically, by photocopy, recording or otherwise, without the prior written permission of Acer Incorporated.

Acer Projector K135/K135P/K135S/L221/LK-W12/K132/L221F/LK-W12L Series

Model number: _____

Serial number: _____

Date of purchase: _____

Place of purchase: _____

Acer and the Acer logo are registered trademarks of Acer Incorporated. Other companies' product names or trademarks are used herein for identification purposes only and belong to their respective companies.

"HDMI™, the HDMI logo and High-Definition Multimedia Interface are trademarks or registered trademarks of HDMI Licensing LLC."

Information for your safety and comfort

Read these instructions carefully. Keep this document for future reference. Follow all warnings and instructions marked on the product.

Turning the product off before cleaning

Unplug this product from the wall outlet before cleaning. Do not use liquid cleaners or aerosol cleaners. Use a damp cloth for cleaning.

Caution for plug as disconnecting device

Observe the following guidelines when connecting and disconnecting power to the external power supply unit:

- Install the power supply unit before connecting the power cord to the AC power outlet.
- Unplug the power cord before removing the power supply unit from the projector.
- If the system has multiple sources of power, disconnect power from the system by unplugging all power cords from the power supplies.

Caution for Accessibility

Be sure that the power outlet you plug the power cord into is easily accessible and located as close to the equipment operator as possible. When you need to disconnect power to the equipment, be sure to unplug the power cord from the electrical outlet.



Warnings!

- Do not use this product near water.
- Do not place this product on an unstable cart, stand or table. If the product falls, it could be seriously damaged.
- Slots and openings are provided for ventilation to ensure reliable operation of the product and to protect it from overheating. These openings must not be blocked or covered. The openings should never be blocked by placing the product on a bed, sofa, rug or other similar surface.

This product should never be placed near or over a radiator or heat register, or in a built-in installation unless proper ventilation is provided.

- Never push objects of any kind into this product through cabinet slots as they may touch dangerous voltage points or short-out parts that could result in a fire or electric shock. Never spill liquid of any kind onto or into the product.

- To avoid damage of internal components and to prevent battery leakage, do not place the product on a vibrating surface.
- Never use it under sporting, exercising, or any vibrating environment which will probably cause unexpected short current or damage rotor devices.

Using electrical power

- This product should be operated from the type of power indicated on the marking label. If you are not sure of the type of power available, consult your dealer or local power company.
- Do not allow anything to rest on the power cord. Do not locate this product where people will walk on the cord.
- If an extension cord is used with this product, make sure that the total ampere rating of the equipment plugged into the extension cord does not exceed the extension cord ampere rating. Also, make sure that the total rating of all products plugged into the wall outlet does not exceed the fuse rating.
- Do not overload a power outlet, strip or receptacle by plugging in too many devices. The overall system load must not exceed 80% of the branch circuit rating. If power strips are used, the load should not exceed 80% of the power strip's input rating.
- This product's AC adapter is equipped with a three-wire grounded plug. The plug only fits in a grounded power outlet. Make sure the power outlet is properly grounded before inserting the AC adapter plug. Do not insert the plug into a non-grounded power outlet. Contact your electrician for details.



.....
Warning! The grounding pin is a safety feature. Using a power outlet that is not properly grounded may result in electric shock and/or injury.



.....
Note: The grounding pin also provides good protection from unexpected noise produced by other nearby electrical devices that may interfere with the performance of this product.

- Use the product only with the supplied power supply cord set. If you need to replace the power cord set, make sure that the new power cord meets the following requirements: detachable type, UL listed/CSA certified, VDE approved or its equivalent, 4.5 meters (15 feet) maximum length.

Product servicing

Do not attempt to service this product yourself, as opening or removing covers may expose you to dangerous voltage points or other risks. Refer all servicing to qualified service personnel.

Unplug this product from the wall outlet and refer servicing to qualified service personnel when:

- the power cord or plug is damaged, cut or frayed
- liquid was spilled into the product
- the product was exposed to rain or water
- the product has been dropped or the case has been damaged
- the product exhibits a distinct change in performance, indicating a need for service
- the product does not operate normally after following the operating instructions



.....

Note: Adjust only those controls that are covered by the operating instructions, since improper adjustment of other controls may result in damage and will often require extensive work by a qualified technician to restore the product to normal condition.



.....

Warning! For safety reasons, do not use non-compliant parts when adding or changing components. Consult your reseller for purchase options.

Your device and its enhancements may contain small parts. Keep them out of the reach of small children.

Additional safety information

- Do not look into the projector's lens when the light is on. The bright may hurt your eyes.
- Turn on the projector first and then signal sources
- Do not place the product in following environments:
 - Space that is poorly ventilated or confined. At least 50cm clearance from walls and free flow of air around the projector is necessary.
 - Locations where temperatures may become excessively high, such as inside of a car with all windows rolled up.
 - Locations where excessive humidity, dust, or cigarette smoke may contaminate optical components, shortening the life span and darkening the image.
 - Locations near fire alarms.
 - Locations with an ambient temperature above 40 °C/104 °F.
 - Locations where the altitudes are higher than 10000 feet.
- Unplug immediately if there is something wrong with your projector. Do not operate if smoke, strange noise or odor comes out of your projector. It

might cause fire or electric shock. In this case, unplug immediately and contact your dealer.

- Do not keep using this product to break or drop it. In this case contact your dealer for inspection.
- Do not face the projector lens to the sun. It can lead to fire.
- When switching the projector off, suggest to ensure the projector completes its cooling cycle before disconnecting power.
- Do not frequently turn off the main power abruptly or unplug the projector during operation. The best way is to wait for the fan to turn off before turning main power off.
- Do not touch air outlet grille and bottom plate which becomes hot.
- Clean the air filter frequently if have. The temperature inside may rise and cause damage when the filter/ventilation slots clogged with dirt or dust.
- Do not look into the air outlet grille when projector is operating. It may hurt your eyes.
- Always open the lens shutter or remove the lens cap when the projector is on.
- Do not block the projector lens with any object when the projector is under operation as this could cause the object to become heated and deformed or even cause a fire.
- Do not attempt to disassemble this projector. There are dangerous high voltages inside which may hurt you. Refer servicing only to suitable qualified professional service personnel.
- Do not stand the projector on end vertically. It may cause the projector to fall over, causing injury or damage.

Caution for Listening

To protect your hearing, follow these instructions.

- Increase the volume gradually until you can hear clearly and comfortably.
- Do not increase the volume level after your ears have adjusted.
- Do not listen to music at high volumes for extended periods.
- Do not increase the volume to block out noisy surroundings.
- Decrease the volume if you can't hear people speaking near you.

Disposal instructions

Do not throw this electronic device into the trash when discarding. To minimize pollution and ensure utmost protection of the global environment, please recycle. For more information on the Waste from Electrical and Electronics Equipment (WEEE) regulations, visit

<http://www.acer-group.com/public/Sustainability/sustainability01.htm>



First things first

Usage Notes

Do:

- Turn off the product before cleaning.
- Use a soft cloth moistened with mild detergent to clean the display housing.
- Disconnect the power plug from AC outlet if the product is not being used for a long period of time.

Don't:

- Block the slots and openings on the unit provided for ventilation.
- Use abrasive cleaners, waxes or solvents to clean the unit.
- Use under the following conditions:
 - In extremely hot, cold or humid environments.
 - In areas susceptible to excessive dust and dirt.
 - Near any appliance that generates a strong magnetic field.
 - Place In direct sunlight.

Precautions

Follow all warnings, precautions and maintenance as recommended in this user's guide to maximize the life of your unit.



Warning:

- Do not look into the projector's lens when the light is on. The bright may hurt your eyes.
- To reduce the risk of fire or electric shock, do not expose this product to rain or moisture.
- Please do not open or disassemble the product as this may cause electric shock.
- When switching the projector off, please ensure the projector completes its cooling cycle before disconnecting power.
- Turn on the projector first and then the signal sources.
- Do not use lens cap when projector is in operation.

Information for your safety and comfort	iii
First things first	viii
Usage Notes	viii
Precautions	viii
Introduction	1
Product Features	1
Package Overview	2
Projector Overview	4
Projector Outlook	4
Control Panel	5
Remote Control Layout	6
MHL (Mobile High-Definition Link) Control	8
Getting Started	10
Connecting the Projector	10
Turning the Projector On/Off	11
Turning on the Projector	11
Turning the projector off	12
Adjusting the Projected Image	13
Adjusting the Height of Projected Image	13
How to optimize image size and distance	14
User Controls	16
Installation menu	16
Onscreen Display (OSD) Menus	17
Color	18
Image	20
Setting	22
Management	22
Audio	23
3D	23
Language	24
Appendices	25
Troubleshooting	25

Contents

LED & Alarm Definition Listing	29
Specifications	30
Compatibility modes	32
Regulations and safety notices	36

Introduction

Product Features

This product is a single-chip DLP® projector. Outstanding features include:

- DLP® technology
- 1280 x 800 WXGA resolution
4:3/16:9/Full/L.Box aspect ratio supported.
- Versatile display modes (Bright, Standard, Movie, Picture, Game, User) enable optimum performance in any situation.
- Compact size projector facilitates business purposes and home entertainment.
- Acer EcoProjeciton Technology delivers Intelligent power management approach and physical efficiency improvement.
- Equipped with HDMI™ connection supporting HDCP.
- Advanced digital keystone correction delivers optimum presentations.
- Multi-language on screen display (OSD) menus.
- 1.7x digital zoom and pan move function.
- Environmental light source and longer life by LED solution.
- Enjoy media playback via USB, RAM and Micro SD card reader. (for K135/K135P/K135S/L221/LK-W12 only)
- Microsoft® Windows® 2000, XP, Vista®, Windows® 7, Windows® 8, Macintosh® OS compliant.
- Support MHL V1.2 signal display.

Package Overview

This projector comes with all the items shown below. Check to make sure your unit is complete. Contact your dealer immediately if any thing is missing.

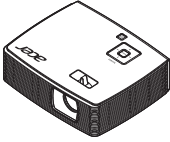

Projector

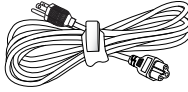

Power cord

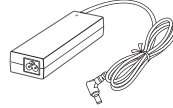

AC to DC power adapter

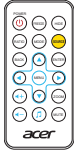

Remote control
(for K132/L221F/LKW12L
series only)



Battery



User's guide

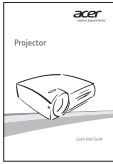

Quick start guide



Carrying case

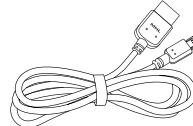

MHL cable (option)

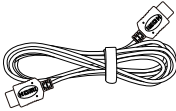

HDMI cable (option)

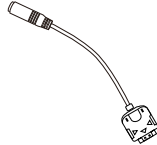

Universal to Audio out
adapter (option)

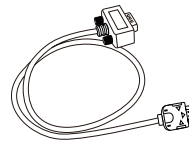

Universal to D-sub cable
(option)

Below items are for K135/K135P/K135S/L221/LK-W12 only:



User's guide
(for multi-media and
wireless functions)



Quick start guide
(for multi-media and
wireless functions)



Remote control



USB WiFi adapter
(option)

Projector Overview

Projector Outlook

Front / upper side

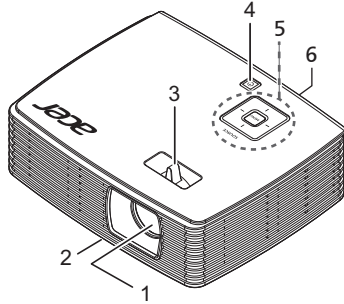

#	Description	#	Description
1	Projection lens	4	Power button
2	Tilt adjusting wheel	5	Control panel
3	Focus ring	6	Remote control receiver

Rear side

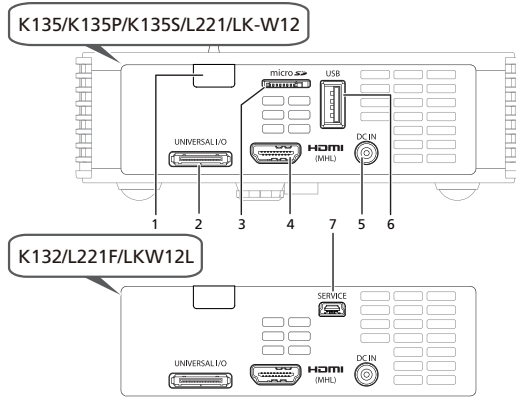

#	Description	#	Description
1	Remote control receiver	5	DC Input
2	Universal connector for VGA in/ Audio out connector	6	USB connector

#	Description	#	Description
3	MicroSD Card Slot	7	Mini USB connector
4	HDMI/ MHL connector		

Control Panel

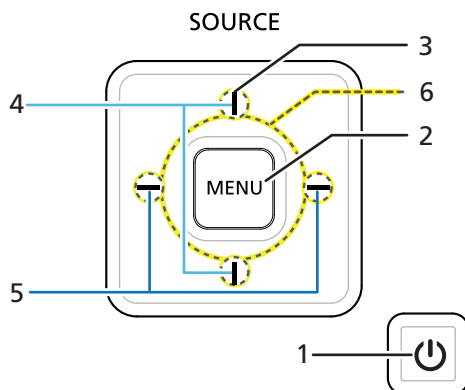





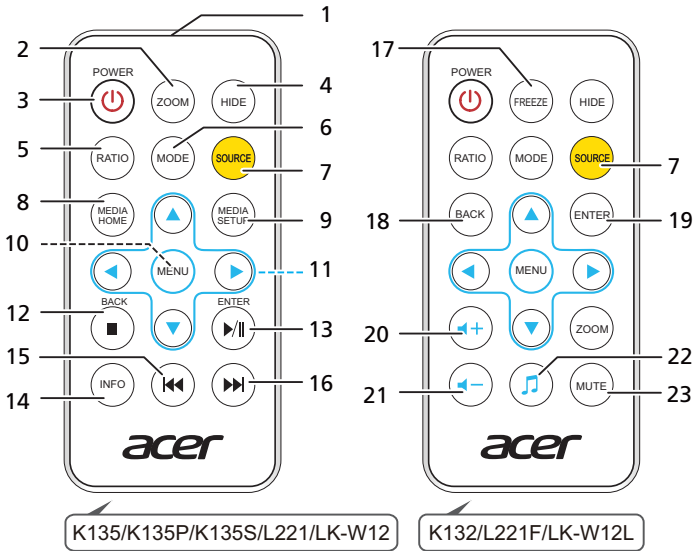



#	Icon	Function	Description
1		POWER	Power button and Power Indicator LED. See the contents in " Turning the Projector On/Off " section.
2		MENU	Press " MENU " to launch the Onscreen display (OSD) menu, back to the previous step for the OSD menu operation or exit the OSD menu.
3		SOURCE	Changes the active source.
4		LAMP	Lamp Indicator LED
5		TEMP	Temp Indicator LED
6		Four directional select keys	Use the keys to select items or make adjustments to your selection.

Remote Control Layout



#	Icon	Function	Description
1		Infrared transmitter	Sends signals to the projector.
2	ZOOM	Zoom	Zooms the projector display in or out.
3	POWER	Power	Refer to the " Turning the Projector On/Off " section.
4	HIDE	Hide	Momentarily turns off the video. Press " HIDE " to hide the image, press again to display the image.
5	RATIO	Aspect ratio	Choose the desired aspect ratio (Auto, Full, 4:3, 16:9, L.Box)
6	MODE	Mode	Press " MODE " to select the display mode from Bright, Standard, Movie, Picture, Game and User.
7	SOURCE	Source	Changes the active source.
8	MEDIA HOME	Media home	Press to return to the Home page of Media mode.
9	MEDIA SETUP	Media setup	Press to enter media OSD setting.
10	MENU	Menu	Press " MENU " to launch the Onscreen display (OSD) menu, back to the previous step for the OSD menu operation or exit the OSD menu.
11	Four directional select keys	Four directional select keys	Use up, down, left, right buttons to select items or make adjustments to your selection.
12	BACK	Back/Stop	Press " Back/Stop " to stop playing media file or go back to upper data folder.
13	ENTER	Enter/ Play/ Pause	Press " Enter/ Play/ Pause " to enter/ play/ pause media file.
14	INFO	Information	To display the projector information.
15	PREVIOUS	Previous	Press to previous the media file.

#	Icon	Function	Description
16		Next	Press to the next media file.
17		Freeze	To pause the screen image.
18		Back	No function.
19		Enter	No function.
20		Volume up	Increases the volume.
21		Volume down	Decreases the volume.
22		Music	No function.
23		Mute	To turn on/off the volume.

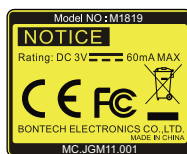
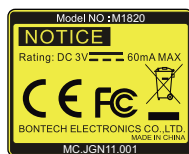

MHL (Mobile High-Definition Link) Control

K135/K135P/K135S/L221/LK-W12

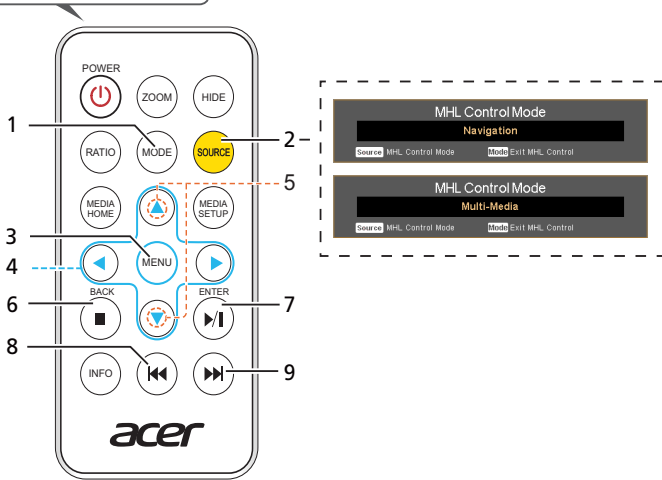

#	Icon	Component	Description
1		MODE	<ul style="list-style-type: none"> Press "MODE" button for one second to activate the MHL Control Mode. To exit, press the "MODE" button again.
2		SOURCE	Press the "SOURCE" button to toggle between Navigation or Multi-Media mode.
3		MENU	Press to launch the root menu. (only for Navigation mode)
4		Direction Keys	Use up, down, left, right buttons to select items or make adjustments to your selection. (only for Navigation mode)
5		Volume Up/ Volume Down	Increases/Decreases the volume. (only for Multi-Media mode)
6		Exit	To exit the file. (only for Navigation mode)
		Stop	To stop the file. (only for Multi-Media mode)
7		Select/Enter	To select the file. (only for Navigation mode)
		Play/Pause	Toggles between playback and pause. (only for Multi-Media mode)
8		Backward	Scans backward during the file playback. (only for Multi-Media mode)
9		Forward	Scans forward through the file playback. (only for Multi-Media mode)

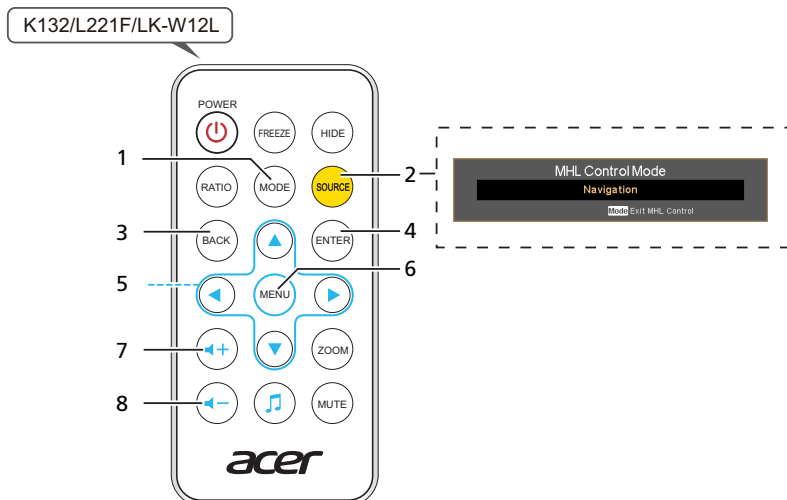

#	Icon	Component	Description
1		MODE	<ul style="list-style-type: none"> Press "MODE" button for one second to activate the MHL Control Mode. To exit, press the "MODE" button again.
2		SOURCE	Press the "SOURCE" button to toggle Navigation mode.
3		Exit	To exit the file.
4		Select/Enter	Press to select/enter the file.
5		Direction Keys	Use up, down, left, right buttons to select items or make adjustments to your selection.
6		MENU	Press to launch the root menu.
7		Volume Up	Press to increase the volume.
8		Volume Down	Press to decreases the volume.

Getting Started

Connecting the Projector

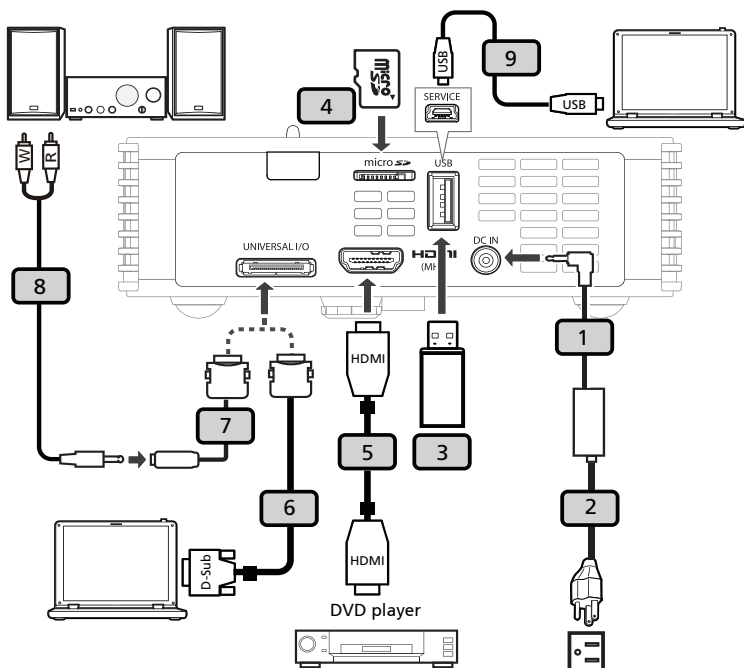

#	Description	#	Description
1	AC to DC power adapter	6	Universal to D-sub cable
2	Power cord	7	Universal to Audio out adapter
3	USB disk/stick USB WiFi adapter	8	Audio cable Jack/RCA
4	Micro SD card	9	USB cable
5	HDMI cable		



Note: To ensure the projector works well with your computer, please make sure the timing of the display mode is compatible with the projector.

Note: USB cable needs powered player extender if the length is over 5 m.

Turning the Projector On/Off

Turning on the Projector

- 1 Ensure that the power cord and signal cable are securely connected. The Power indicator LED will flash red.
- 2 Turn on the projector by pressing "**Power**" button on the control panel, and the Power indicator LED will turn blue.(Illustration #1)
- 3 Turn on your source (computer, notebook, video player ,etc.). The projector will detect your source automatically.
 - If the screen displays "No Signal", please make sure the signal cables are securely connected.
 - If you connect to multiple sources at the same time, use the "Source" button on either control panel or the remote control or direct source key on the remote control to switch between inputs.

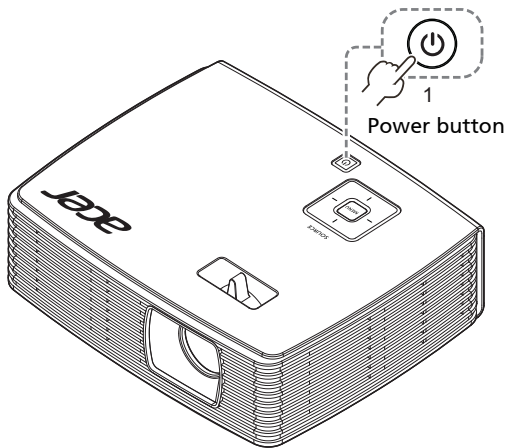

Turning the projector off

- 1 To turn the projector off, press the power button. This message appears: **"Please press the power button again to complete the shutdown process."** Press the power button again.
- 2 The LED power indicator will stop blinking and turn solid red to indicate standby mode after the projector is turned off.
- 3 It is now safe to unplug the power cord.



Warning indicators:

- **"Projector Overheated. Will automatically turn off soon."**
This onscreen message indicates that the projector has overheated. The projector will automatically shut down. Contact your local dealer or service center.
- **"Fan failed. Will automatically turn off soon."**
This onscreen message indicates that the fan has failed. The projector will automatically shut down. Contact your local dealer or service center.



Note: Whenever the projector automatically shuts down, contact your local reseller or service center.

Adjusting the Projected Image

Adjusting the Height of Projected Image

The projector is equipped with tilt adjusting wheel for adjusting the height of image.

To raise/lower the image:

- 1 Use Tilt adjusting wheel to fine-tune the display angle.

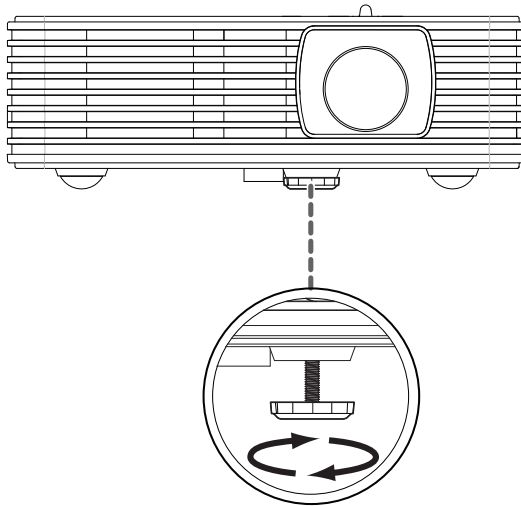

Tilt adjusting wheel

How to optimize image size and distance

Consult the table below to find the optimal image sizes achievable when the projector is positioned at a desired distance from the screen. Example: If the projector is 1.34 m from the screen, good image quality is possible for image sizes 41.5".



Note: Remind as below figure, the space of 56 cm height is required when located at 1.34 m distance.

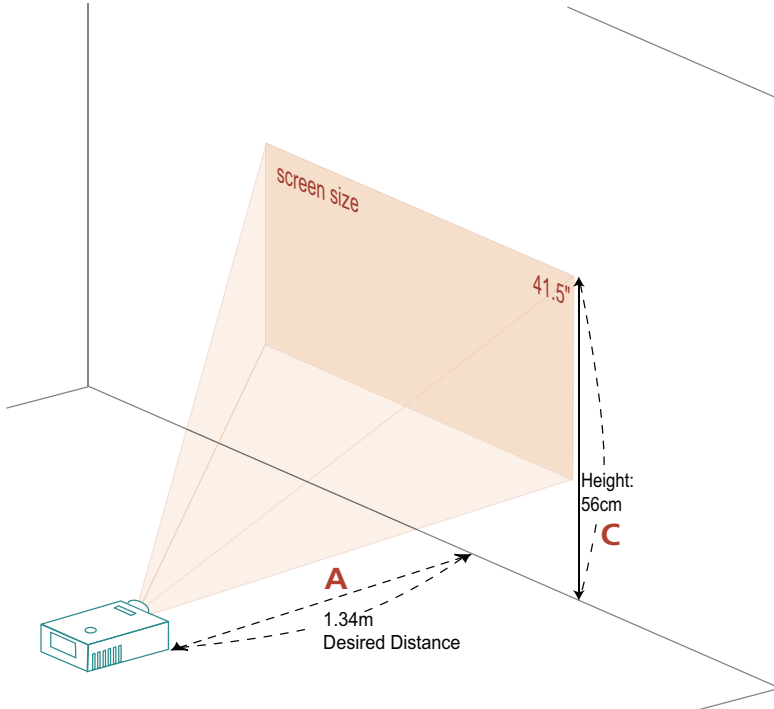

Desired Distance (m) <A>	Screen size		Top
	(Min zoom)		
	Diagonal (inch) 	W (cm) x H (cm)	From base to top of image (cm) <C>
0.97	30.0	64 x 40	40
1.07	33.2	71 x 45	45
1.34	41.5	89 x 56	56
1.61	49.7	107 x 67	67
2.14	66.3	143 x 89	89
2.58	80.0	172 x 108	108

Zoom Ratio: 1.0x

User Controls

Installation menu

The installation menu provides an onscreen display (OSD) for projector installation and maintenance. Use the OSD only when the message "No signal input" is displayed on the screen.

The menu options include settings and adjustments for screen size and distance, focus, keystone correction and more .

- 1 Turn on the projector by pressing "**Power**" button on the control pad.
- 2 Press the "**MENU**" button on the control pad to launch the OSD for projector installation and maintenance.

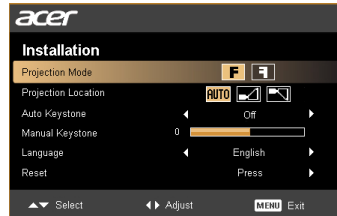
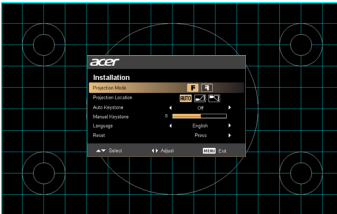

- 3 The background pattern acts as a guide to adjusting the calibration and alignment settings, such as screen size and distance .
- 4 The Installation menu includes the following options:
 - Projection Mode
 - Projection Location
 - Auto Keystone settings
 - Manual Keystone settings
 - Language settings
 - Reset to factory default function







Use the up and down arrow keys to select an option, the left and right arrow keys to adjust selected option settings, and the right arrow key to enter a submenu for feature setting. The new settings will be saved automatically upon exiting the menu.

- 5 Push the menu button anytime to exit the menu and return to the Acer welcome screen.

Onscreen Display (OSD) Menus

The projector has multilingual OSD that allow you to make image adjustments and change a variety of settings.

Using the OSD menus

- To open the OSD menu, press **"MENU"** on the remote control.
- When the OSD is displayed, use the   keys to select any item in the main menu. After selecting the desired main menu item, press  to enter submenu for feature setting.
- Use the   keys to select the desired item and adjust the settings by using the   keys.
- Select the next item to be adjusted in the submenu and adjust as described above.
- Press **"MENU"** on the remote control, the screen will return to the main menu.
- To exit OSD, press **"MENU"** on the remote control again. The OSD menu will close and the projector will automatically save the new settings.

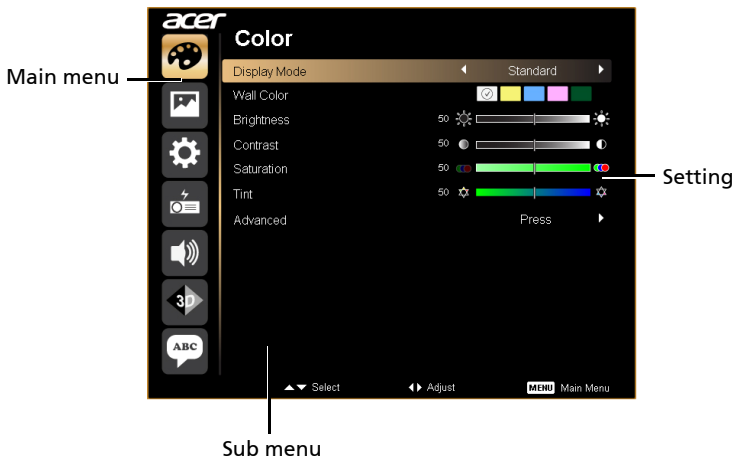

Color

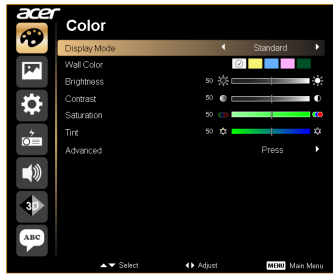

Display Mode	<p>There are many factory presets optimized for various types of images.</p> <ul style="list-style-type: none"> • Bright: For brightness optimization. • Standard: For common environment. • Movie: For brighter and general movie/video/photo playing. • Picture: For graphic picture. • Game: For game content. • User: Memorize user's settings.
Wall color	<p>Use this function to choose a proper color according to the wall. There are several choices, including white, light yellow, light blue, pink, dark green. It will compensate the color deviation due to the wall color to show the correct image tone.</p>
Brightness	<p>Adjust the brightness of the image.</p> <ul style="list-style-type: none"> • Press ◀ to darken image. • Press ▶ to lighten the image.
Contrast	<p>"Contrast" controls the difference between the lightest and darkest parts of the picture. Adjusting the contrast changes the amount of black and white in the image.</p> <ul style="list-style-type: none"> • Press ◀ to decrease the contrast. • Press ▶ to increase the contrast.
Saturation	<p>Adjusts a video image from black and white to fully saturated color.</p> <ul style="list-style-type: none"> • Press ◀ to decrease the amount of color in the image. • Press ▶ to increase the amount of color in the image.
Tint	<p>Adjusts the color balance of red and green.</p> <ul style="list-style-type: none"> • Press ◀ to increase the amount of green in the image. • Press ▶ to increase the amount of red in the image.

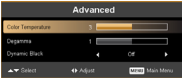



<p>Advanced</p> 	<p>Color Temperature Adjust the color temperature. At higher color temperatures, the screen looks colder; at lower color temperatures, the screen looks warmer.</p>
	<p>Degamma Effects the representation of dark scenery. With greater gamma value, dark scenery will look brighter.</p>
	<p>Dynamic Black Choose "On" to automatically optimize the display of dark movie scenes enabling them to be shown in incredible detail.</p>

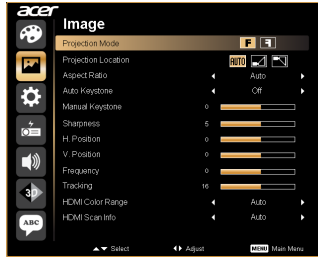

Note: "Saturation" and "Tint" functions are not supported under computer mode or HDMI mode.

Image

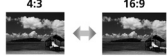

<p>Projection Mode</p> 	<ul style="list-style-type: none"> • Front: The factory default setting. • Rear: Reverses the image so you can project from behind a translucent screen.
<p>Projection Location</p> 	<ul style="list-style-type: none"> • Auto: Automatically adjusts projection location of image. • Desktop • Ceiling: Turns the image upside down for ceiling-mounted projection.
<p>Aspect Ratio</p> 	<p>Use this function to choose your desired aspect ratio.</p> <ul style="list-style-type: none"> • Auto: Keep the image with original width-highth ratio and maximize the image to fit native horizontal or vertical pixels. • 4:3: The image will be scaled to fit the screen and displayed using a 4:3 ratio. • 16:9: The image will be scaled to fit the width of the screen and the height adjusted to display the image using a 16:9 ratio. • Full: Resize image to fit full screen by width (1280 pixels) and height (800 pixels). • L.Box: Keep original signal aspect ratio and zoom in by 1.333 times.
<p>Auto Keystone</p>	<p>Automatically adjusts vertical image.</p>
<p>Manual Keystone</p>	<p>Adjust image distortion caused by tilting projection. (±40 degrees)</p>  <p><Note> The Manual Keystone function is unavailable under Auto Keystone setting to "On".</p>
<p>Sharpness</p>	<p>Adjusts the sharpness of the image.</p> <ul style="list-style-type: none"> • Press ◀ to decrease the sharpness. • Press ▶ to increase the sharpness.

H. Position	<ul style="list-style-type: none"> ● Press ◀ to move the image left. ● Press ▶ to move the image right.
V. Position	<ul style="list-style-type: none"> ● Press ▼ to move the image down. ● Press ▲ to move the image up.
Frequency	"Frequency" changes the projector's refresh rate to match the frequency of your computer's graphics card. If you can see a vertical flickering bar in the projected image, use this function to make the necessary adjustments.
Tracking	Synchronizes the signal timing of the projector with the graphics card. If you experience an unstable or flickering image, use this function to correct it.
HDMI Color Range	Adjust the color range of the HDMI image data to correct color display error. <ul style="list-style-type: none"> ● Auto: Automatically adjust by information from player. ● Limited Range: Process the input image as limited color range data. ● Full Range: Process the input image as full color range data.
HDMI Scan Info	Adjust the overscan ratio of the HDMI image on screen. <ul style="list-style-type: none"> ● Auto: Automatically adjust by information from player. ● Underscan: Always no overscan on HDMI image. ● Overscan: Always keep overscan on HDMI image.



.....

Note: "H. Position", "V. Position", "Frequency" and "Tracking" functions are not supported under HDMI, DVI or Video mode.

Note: "Sharpness" functions is not supported under HDMI (RGB) or Computer mode.

Note: "HDMI Color Range" and "HDMI Scan Info" functions are only supported under HDMI mode.

Setting



Menu Location	Choose the menu location on the display screen.
Reset	Press the  button and choose "Yes" to return the parameters on all menus to the factory default settings.

Management



ECO Mode	Choose "On" to dim the projector lamp which will lower power consumption, extend the lamp life and reduce noise. Choose "Off" to return normal mode.
High Altitude	Choose "On" to turn on High Altitude mode. Operate the fans at full speed continuously to allow for proper high altitude cooling of the projector.
Turn Off Mode	<ul style="list-style-type: none"> Instant Off: Shuts down the projector without fan cooling. Instant Resume: Resumes the system when the Power button is pressed again within 2 minutes.
Auto Shutdown	The projector will automatically shutdown when there is no signal input after the allocated time. (default is 120 minutes)
LED Calibration	Press  after choosing "Yes", please wait for 10 seconds to finish the white color fine tune process. It helps to adjust LED color performance.

Audio



Volume	<ul style="list-style-type: none"> Press ◀ to decrease the volume. Press ▶ to increase the volume.
Mute	<ul style="list-style-type: none"> Choose "On" to mute the volume. Choose "Off" to restore the volume.
Alarm Volume	<ul style="list-style-type: none"> Select this function to adjust the volume of any warning notifications.
Audio Out	<ul style="list-style-type: none"> Choose "Speaker" to play sound through the projector's speaker.(internal) Choose "Audio Jack " to play sound from your headphone or audio amplifier. (external)

3D



3D	<p>Choose "On" to enable DLP 3D function.</p> <ul style="list-style-type: none"> On: Choose this item while using DLP 3D glasses, quad buffer (NVIDIA/ATI...) graphic card and HQFS format file or DVD with corresponding SW player. Off: Turn off 3D mode.
3D Sync Invert	<p>If you see a discrete or overlapping image while wearing DLP 3D glasses, you may need to execute "Invert" to get best match of left/right image sequence to get the correct image (for DLP 3D).</p>

3D Warning Message	<p>Choose "On" to display the 3D warning message.</p> <div data-bbox="358 172 841 296" style="background-color: black; color: white; padding: 5px;"> <p>Note: 3D display is now enabled.</p> <ol style="list-style-type: none"> 1. Please make sure you have the correct 3D signals and glasses. 2. Remember to turn 3D off if you don't want to see 3D images. 3. If the 3D display isn't correct, please try to enable 3D Sync Invert. 4. Display mode options will be disabled while in 3D mode. </div>
--------------------	------------------------------------------------------------------------------------------------------------------------------------------------------------------------------------------------------------------------------------------------------------------------------------------------------------------------------------------------------------------------------------------------------------------------------------------------------------------------------------------------------------------------------------------------------



Note: It needs correct settings on graphic card 3D application program for correct 3D display.

Note: The SW players, such as Stereoscopic Player and DDD TriDef Media Player can support 3D format files. You can download these three players on web page below,

- Stereoscopic Player (Trial): http://www.3dtv.at/Downloads/Index_en.aspx
 - DDD TriDef Media Player (Trial):



<http://www.tridef.com/download/TriDef-3-D-Experience-4.0.2.html>

Note: "3D Sync Invert" is only available when 3D is enabled.

Note: There has reminder screen if 3D still enable when power on projector. Please adjust setting depended on your purpose.

Language



Language	<p>Choose the multilingual OSD menu. Use the  or  key to select your preferred menu language.</p> <ul style="list-style-type: none"> • Press  to confirm the selection.
----------	-------------------------------------------------------------------------------------------------------------------------------------------------------------------------------------------------------------------------------------------------------------------------------------------------------------------------------------------------------------------------------------------------------------------------------------------------

Appendices

Troubleshooting

If you experience a problem with your Acer projector, refer to the following troubleshooting guide. If the problem persists, please contact your local reseller or service center.

Image Problems and Solutions

#	Problem	Solution
1	No image appears onscreen	<ul style="list-style-type: none"> • Connected as described in the "Getting Started" section. • Ensure none of the connector pins are bent or broken. • Make sure the projector is switched on.
2	Partial, scrolling or incorrectly displayed image (For PC (Windows 95/98/2000/XP/Vista/Win7/Win 8))	<ul style="list-style-type: none"> • For an incorrectly displayed image: <ul style="list-style-type: none"> • Open "My Computer," open the "Control Panel," and then double-click the "Display" icon. • Select the "Settings" tab. • Verify that your display resolution setting is lower than or equal to 1080P-EIA. • Click the "Advanced Properties" button. • If the problem still appears, change the monitor display you are using and follow the steps below: <ul style="list-style-type: none"> • Verify that the resolution setting is lower than or equal to 1080P-EIA. • Click the "Change" button under the "Monitor" tab. • Click "Show all devices". Next, select "Standard monitor types" under the SP box, and choose the resolution mode you need under the "Models" box. • Verify that the resolution setting of the monitor display is lower than or equal to 1080P-EIA.

3	Partial, scrolling or incorrectly displayed image (for notebooks)	<ul style="list-style-type: none"> • For an incorrectly displayed image: <ul style="list-style-type: none"> • Follow the steps for item 2 (above) to adjust the resolution of your computer. • Press the toggle output settings. Example: [Fn]+[F4], Compaq [Fn]+[F4], Dell [Fn]+[F8], Gateway [Fn]+[F4], IBM [Fn]+[F7], HP [Fn]+[F4], NEC [Fn]+[F3], Toshiba [Fn]+[F5] • If you experience difficulty changing resolutions or your monitor freezes, restart all equipment including the projector.
4	The screen of the notebook computer is not displaying your presentation	<ul style="list-style-type: none"> • If you are using a Microsoft® Windows® based notebook: Some notebook PCs may deactivate their own screens when a second display device is in use. Each has a different way to be reactivated. Refer to your computer's manual for detailed information. • If you are using an Apple® Mac® OS based notebook: In System Preferences, open Display and select Video Mirroring "On".
5	Image is unstable or flickering	<ul style="list-style-type: none"> • Adjust the "Tracking" to correct it. Refer to the "Image" section for more information. • Change the display color depth settings on your computer.
6	Image has vertical flickering bar	<ul style="list-style-type: none"> • Use "Frequency" to make an adjustment. Refer to the "Image" section for more information. • Check and reconfigure the display mode of your graphics card to make it compatible with the projector.
7	Image is out of focus	<ul style="list-style-type: none"> • Adjusts the focus ring on the projector lens. • Make sure the projection screen is within the required distance of 3.18-8.46 feet (0.97-2.58 meters) from the projector. Refer to the "How to Get a Preferred Image Size by Adjusting Distance and Zoom" section for more information.
8	Image is stretched when displaying a "widescreen" DVD title	<p>When you play a DVD encoded in anamorphic or 16:9 aspect ratio you may need to adjust the following settings:</p> <ul style="list-style-type: none"> • If you play a 4:3 format DVD title, please change the format to 4:3 in the projector OSD. • If the image is still stretched, you will also need to adjust the aspect ratio. Set up the display format to 16:9 (wide) aspect ratio on your DVD player. • If you play an Letterbox(LBX) format DVD title, please change the format to Letterbox(LBX) in the projector OSD.

9	Image is too small or too large	<ul style="list-style-type: none"> • Adjust the zoom ring on the top of the projector. • Move the projector closer to or further from the screen. • Press "MENU" on the remote control or on the control panel. Go to "Image --> Aspect Ratio" and try different settings.
10	Image has slanted sides	<ul style="list-style-type: none"> • If possible, reposition the projector so that it is centered on the screen. • Press the "Keystone" on the OSD until the sides are vertical.
11	Image is reversed	<ul style="list-style-type: none"> • Select "Image --> Projection Mode" on the OSD and adjust the projection direction.

Problems with the Projector

#	Condition	Solution
1	The projector stops responding to all controls	If possible, turn off the projector, then unplug the power cord and wait at least 30 seconds before reconnecting power.

OSD Messages

#	Condition	Message Reminder
1	Message	<p data-bbox="369 277 710 300">Fan Fail - the system fan is not working.</p> <div data-bbox="358 320 921 384" style="background-color: black; color: white; text-align: center; padding: 5px;"> <p data-bbox="547 335 743 371">Fan Fail. Will automatically turn off soon</p> </div> <p data-bbox="369 405 907 469">Projector Overheated - the projector has exceeded its recommended operating temperature and must be allowed to cool down before it may be used.</p> <div data-bbox="358 489 921 553" style="background-color: black; color: white; text-align: center; padding: 5px;"> <p data-bbox="555 499 754 536">Projector Overheated. Will automatically turn off soon</p> </div>

LED & Alarm Definition Listing

LED Messages

Message	Menu	Lamp (UP/Down LED)	Temp (Left/Right LED)	Power LED	Power LED
	BLUE	BLUE	BLUE	RED	BLUE
Input Power Plug	---	Flash On to OFF 100ms	Flash On to OFF 100ms	Flash On to OFF 100ms	---
Standy by	---	---	---	ON	---
Power button on	ON 1sec then off	ON 1sec then off	ON 1sec then off	---	ON
Lamp retry	---	---	---	---	Quick Flashing
Power button OFF; Standby Mode)	---	---	---	ON	---
Error (Thermal fail)	---	---	ON	---	ON
Error (Fan Lock)	---	---	Quick Flashing	---	ON
Error (Lamp Break down)	---	ON	---	---	ON



.....

Note: When power on, click any key, Menu/Up/Down/Left/Right key LED will all be trigger.

Specifications

The specifications listed below are subject to change without notice. For final specs, please refer to Acer's published marketing specifications.

Projection system	DLP®
Resolution	WXGA (1280 x 800)
Computer compatibility	IBM PC and compatibles, Apple Macintosh, iMac and VESA standards: SXGA, XGA, SVGA, VGA, WXGA
Aspect ratio	Full, 4:3, 16:9, L.Box
Displayable colors	16.7 million colors
Projection lens	YM101, fixed lens, F/2.0
Projection screen size (diagonal)	30" (0.76 m) - 80" (2.03 m)
Projection distance	3.18' (0.97 m) - 8.46' (2.58 m)
Throw ratio	40" @ 1.292 m (1.5:1)
Horizontal scan rate	30 k - 100 kHz
Vertical refresh scan rate	50 - 120 Hz
Keystone correction	+/- 40 degrees
Weight	K135/K135P/K135S/L221/LK-W12: 0.43 Kg (0.95 lbs) K132/L221F/LK-W12L: 0.415 Kg (0.92 lbs)
Dimensions (W x D x H)	140 mm x 116 mm x 41 mm (5.51" x 4.57" x 1.61")
Power supply	AC 100 – 240 V, 50-60 Hz
Power consumption	Normal mode: 55 W +/- 20% @ 110 Vac (Bright mode @ full power) ECO mode: 45 W +/-20% @ 110 Vac (Movie mode @ eco power) Standby < 0.5 W
Operating temperature	5 °C to 40 °C / 41 °F to 104 °F
I/O connectors	<ul style="list-style-type: none"> • DC input x1 • Micro SD x1 (for K135/K135P/K135S/L221/LK-W12 only) • USB x1: for multimedia (for K135/K135P/K135S/L221/LK-W12 only) • Mini USB x1 (for K132/L221F/LK-W12L only) • HDMI (MHL) x1 • Universal input x1

Standard package contents

- Power cord x1
 - Remote control x1
 - Battery x1 (for remote control)
 - User's guide (CD-ROM) x1 (for projector function)
 - User's guide (CD-ROM) x1 (for multi-media and wireless functions) (for K135/K135P/K135S/L221/LK-W12 only)
 - Quick start guide x1 (for projector function)
 - Quick start guide x1 (for multi-media and wireless functions) (for K135/K135P/K135S/L221/LK-W12 only)
 - Carrying case x1
-

* Design and specifications are subject to change without notice.

Compatibility modes

A. VGA Analog

1 VGA Analog - PC Signal

Modes	Resolution	V.Frequency [Hz]	H.Frequency [KHz]
VGA	640x480	60	31.5
	640x480	72	37.9
	640x480	75	37.5
	640x480	85	43.3
	640x480	120	61.9
SVGA	800x600	56	35.1
	800x600	60	37.9
	800x600	72	48.1
	800x600	75	46.9
	800x600	85	53.7
	800x600	120	77.4
XGA	1024x768	60	48.4
	1024x768	70	56.5
	1024x768	75	60.0
	1024x768	85	68.7
	1024x768	120	99.0
SXGA	1152x864	70	63.8
	1152x864	75	67.5
	1152x864	85	77.1
	1280x1024	60	64.0
	1280x1024	72	77.0
QuadVGA	1280x1024	75	80.0
	1280x960	60	60.0
	1280x960	75	75.2
SXGA+	1400x1050	60	65.3
PowerBook G4	640x480	60	31.4
PowerBook G4	640x480	66.6 (67)	34.9
PowerBook G4	800x600	60	37.9
PowerBook G4	1024x768	60	48.4
PowerBook G4	1152x870	75	68.7
PowerBook G4	1280x960	75	75.0
i Mac DV (G3)	1024x768	75	60.0

2 VGA Analog - Extended Wide timing

Modes	Resolution	V.Frequency [Hz]	H.Frequency [KHz]
WXGA	1280x768	60	47.8
	1280x768	75	60.3
	1280x768	85	68.6
	1280x720	60	44.8
	1280x800	60	49.6
WSXGA+	1440x900	60	59.9
	1680x1050	60	65.3
	1920x1080 (Reduced Blanking Timing)	60	66.6
	1366x768	60	47.7

3 VGA Analog - Component Signal

Modes	Resolution	V.Frequency [Hz]	H.Frequency [KHz]
480i	720x480	59.94(29.97)	15.7
576i	720x576	50(25)	15.6
480p	720x480	59.94	31.5
576p	720x576	50	31.3
720p	1280x720	60	45.0
720p	1280x720	50	37.5
1080i	1920x1080	60 (30)	33.8
1080i	1920x1080	50 (25)	28.1
1080p	1920x1080	60	67.5
1080p	1920x1080	50	56.3

B. HDMI Digital

1 HDMI - PC Signal

Modes	Resolution	V.Frequency [Hz]	H.Frequency [KHz]
VGA	640x480	60	31.5
	640x480	72	37.9
	640x480	75	37.5
	640x480	85	43.3
	640x480	120	61.9
SVGA	800x600	56	35.1
	800x600	60	37.9
	800x600	72	48.1
	800x600	75	46.9
	800x600	85	53.7
	800x600	120	77.4

XGA	1024x768	60	48.4
	1024x768	70	56.5
	1024x768	75	60.0
	1024x768	85	68.7
	1024x768	120	99.0
SXGA	1152x864	70	63.8
	1152x864	75	67.5
	1152x864	85	77.1
	1280x1024	60	64.0
	1280x1024	72	77.0
QuadVGA	1280x1024	75	80.0
	1280x960	60	60.0
	1280x960	75	75.2
SXGA+	1400x1050	60	65.3
PowerBook G4	640x480	60	31.4
PowerBook G4	640x480	66.6 (67)	34.9
PowerBook G4	800x600	60	37.9
PowerBook G4	1024x768	60	48.4
PowerBook G4	1152x870	75	68.7
PowerBook G4	1280x960	75	75.0
i Mac DV (G3)	1024x768	75	60.0

2 HDMI - Extended Wide timing

Modes	Resolution	V.Frequency [Hz]	H.Frequency [KHz]
WXGA	1280x768	60	47.8
	1280x768	75	60.3
	1280x768	85	68.6
	1280x720	60	44.8
	1280x800	60	49.6
	1440x900	60	59.9
WSXGA+	1680x1050	60	65.3
	1920x1080 (Reduced Blanking Timing)	60	66.6
	1366x768	60	47.7

3 HDMI - Video Signal

Modes	Resolution	V.Frequency [Hz]	H.Frequency [KHz]
480i	720x480(1440x480)	59.94 (29.97)	15.7
576i	720x576(1440x576)	50 (25)	15.6
480p	720x480	59.94	31.5
576p	720x576	50	31.3
720p	1280x720	60	45.0
720p	1280x720	50	37.5
1080i	1920x1080	60 (30)	33.8
1080i	1920x1080	50 (25)	28.1
1080p	1920x1080	60	67.5
1080p	1920x1080	50	56.3
Graphic source monitor range limits	Horizontal scan rate:	30k~100kHz	
	Vertical scan rate:	50~120Hz	
	Max. pixel rate	150MHz	

Regulations and safety notices

FCC notice

This device has been tested and found to comply with the limits for a Class B digital device pursuant to Part 15 of the FCC rules. These limits are designed to provide reasonable protection against harmful interference in a residential installation. This device generates, uses, and can radiate radio frequency energy and, if not installed and used in accordance with the instructions, may cause harmful interference to radio communications.

However, there is no guarantee that interference will not occur in a particular installation. If this device does cause harmful interference to radio or television reception, which can be determined by turning the device off and on, the user is encouraged to try to correct the interference by one or more of the following measures:

- Reorient or relocate the receiving antenna.
- Increase the separation between the device and receiver.
- Connect the device into an outlet on a circuit different from that to which the receiver is connected.
- Consult the dealer or an experienced radio/television technician for help.

Notice: Shielded cables

All connections to other computing devices must be made using shielded cables to maintain compliance with FCC regulations.

Notice: Peripheral devices

Only peripherals (input/output devices, terminals, printers, etc.) certified to comply with the Class B limits may be attached to this equipment. Operation with non-certified peripherals is likely to result in interference to radio and TV reception.

Caution

Changes or modifications not expressly approved by the manufacturer could void the user's authority, which is granted by the Federal Communications Commission, to operate this device.

Operation conditions

This device complies with Part 15 of the FCC Rules. Operation is subject to the following two conditions: (1) this device may not cause harmful interference, and (2) this device must accept any interference received, including interference that may cause undesired operation.

Notice: Canadian users

This Class B digital apparatus complies with Canadian ICES-003.

Remarque à l'intention des utilisateurs canadiens

Cet appareil numérique de la classe B est conforme à la norme NMB-003 du Canada.

Declaration of Conformity for EU countries

Acer hereby declares that this projector series is in compliance with the essential requirements and other relevant provisions of Directive 1999/5/EC.

Compliant with Russian regulatory certification



ME61 UA.TR.002

Radio device regulatory notice



Note: The regulatory information below is for models with wireless LAN and/or Bluetooth only.

General

This product complies with the radio frequency and safety standards of any country or region in which it has been approved for wireless use. Depending on configurations, this product may or may not contain wireless radio devices (such as wireless LAN and/or Bluetooth modules).

Canada — Low-power license-exempt radio communication devices (RSS-210)

- a Common information
 - Operation is subject to the following two conditions:
 1. This device may not cause interference, and
 2. This device must accept any interference, including interference that may cause undesired operation of the device.
- b Operation in 2.4 GHz band
 - To prevent radio interference to the licensed service, this device is intended to be operated indoors and installation outdoors is subject to licensing.

List of applicable countries

This device must be used in strict accordance with the regulations and constraints in the country of use. For further information, please contact the local office in the country of use. Please see <http://ec.europa.eu/enterprise/rtte/implem.htm> for the latest country list.



Acer Incorporated
8F, 88, Sec. 1, Xintai 5th Rd., Xizhi
New Taipei City 221, Taiwan

Declaration of Conformity

We,

Acer Incorporated

8F, 88, Sec. 1, Xintai 5th Rd., Xizhi, New Taipei City 221, Taiwan

Contact Person: Mr. RU Jan, e-mail: ru.jan@acer.com

And,

Acer Italy s.r.l

Via Lepetit, 40, 20020 Lainate (MI) Italy

Tel: +39-02-939-921 ,Fax: +39-02 9399-2913

www.acer.it

Declare under our own responsibility that the product:

Product: **Projector**

Trade Name: **Acer**

Model Number: **CWX1137/CWX1147**

K135/K135P/K135S/L221/LK-W12/K132/L221F/LK-W12L

To which this declaration refers conforms to the relevant standard or other standardizing documents:

- EN 55022:2006/A1:2007 Class B; EN 55024:2010
- EN 61000-3-2:2006+A1:2009+A2:2009 Class A; EN61000-3-3:2008
- EN 60950-1:2006+A11:2009+A1:2010+A12:2011
- EN 50581:2012
- Regulation (EC) No. 1275/2008; EN 62301:2005

We hereby declare above product is in compliance with the essential requirements and other relevant provisions of EMC Directive 2004/108/EC, Low Voltage Directive 2006/95/EC, RoHS Directive 2011/65/EU and Directive 2009/125/EC with regard to establishing a framework for the setting of ecodesign requirements for energy-related product.

Year to begin affixing CE marking 2013.

RU Jan / Sr. Manager
Regulation, Acer Inc.

Mar. 8, 2013
Date



Acer America Corporation
333 West San Carlos St.,
Suite 1500
San Jose, CA 95110
U. S. A.
Tel: 254-298-4000
Fax: 254-298-4147
www.acer.com



Federal Communications Commission Declaration of Conformity

This device complies with Part 15 of the FCC Rules. Operation is subject to the following two conditions: (1) this device may not cause harmful interference, and (2) this device must accept any interference received, including interference that may cause undesired operation.

The following local Manufacturer / Importer is responsible for this declaration:

Product:	DLP Projector
Model Number:	CWX1137/CWX1147
Machine Type:	K135/K135P/K135S/L221/LK-W12/K132/ L221F/LK-W12L
Name of Responsible Party:	Acer America Corporation
Address of Responsible Party:	333 West San Carlos St. Suite 1500 San Jose, CA 95110 U. S. A.
Contact Person:	Acer Representative
Phone No.:	254-298-4000
Fax No.:	254-298-4147