

SONY.



VPL-C Series

Compact Data Projector



sony.com/projectors

The VPL-C Series – A New and Powerful Line of Projectors Designed to Meet the Needs of Medium-Sized Corporate Conference Rooms and School Classrooms

The new Sony VPL-C Series is composed of six projectors, each specifically designed to match your requirements for powerful presentations in both the classroom and conference room. The VPL-CW125 boasts WXGA resolution, which is ideal for presentations from a wide-screen source such as a WXGA PC or a 16:9 aspect-ratio video. The rest of the VPL-C Series of projectors has native XGA (1024 x 768) resolution for projecting high-quality images. The brightness range of these projectors is 2700 to 3500 lumens depending on the model, enabling bright presentations even in ambient light conditions. Furthermore, a newly developed lens provides crisp and clear images with minimal aberration.







Designed with installation flexibility and easy maintenance in mind, the new Sony VPL-C Series is a delight for system integrators and maintenance staff. These projectors have multiple video and audio interfaces, enabling them to be configured with a variety of equipment. They are also designed for easy lamp replacement and filter cleaning. The VPL-CW125, VPL-CX155, and VPL-CX125 each have a network interface that enables presentations and maintenance over IP networks.

A number of other useful features includes vertical and horizontal keystone*¹ correction, smart APA, and direct power on/off. For classroom settings, security features such as a control panel key lock, password authentication system, and a security bar can prove indispensable.

The attractive, bright, and flexible VPL-C Series of projectors is ideal for use in medium-sized corporate conference rooms, school classrooms, and several other environments.

*¹ Horizontal keystone correction is available on the VPL-CW125, VPL-CX155, and VPL-CX125 only.

The New VPL-C Series at a Glance

	VPL-CW125 ²	VPL-CX155	VPL-CX150	VPL-CX125	VPL-CX120	VPL-CX100
						
Resolution	WXGA			XGA (1024 x 768)		
Brightness	3000 lm	3500 lm		3000 lm		2700 lm
Network Capable	Yes		No	Yes	No	
Side Shot™ Horizontal Keystone Correction	Yes		No	Yes	No	
Remote Commander™ Unit	Multi-function		Card Type	Multi-function	Card Type	

² The VPL-CW125 is planned to be available in the fall of 2007. Specifications are based on current information.

High Picture Quality and Bright Images

The VPL-CW125 incorporates three high-aperture 0.74-inch LCD panels with WXGA resolution so that images from WXGA sources are projected with the correct aspect ratio. This highly efficient projector achieves a brightness of 3000 lumens from a 200 W lamp. The rest of the projectors in the new VPL-C Series lineup provide native XGA (1024 x 768) resolution with a brightness of 3500, 3000, or 2700 lumens depending on the model. In addition, all of these projectors incorporate a newly designed ACF (Advanced Crisp Focus) glass lens for projecting crisp and beautiful images right to the very corners of the screen (Fig. 1) . Choose the right projector to match the environment.



VPL-C Series

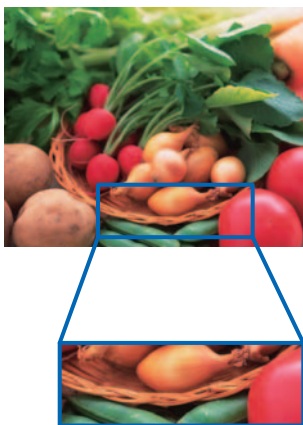

Conventional Projectors

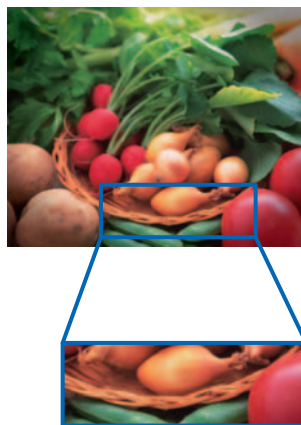

Fig. 1 ACF Lens vs. Conventional Lens

(simulated images)

3LCD Projection System

Because the new VPL-C Series uses a 3LCD projection system, projected images are bright and natural. 3LCD is a projection system using three LCD panels, which is also known as HTPS (High-Temperature Polysilicon). This system provides high light transmission and excellent color reproduction. It also provides smooth gradients in dark areas, and even helps prevent color breakup.

Installation Flexibility and Easy Maintenance

Multiple Interfaces for Flexible Configurations

The VPL-C Series of projectors accepts a wide variety of input signals, including component and composite video, S-Video (Y/C), and computer signals up to SXGA+ (fV: 60 Hz) – providing multiple source options. They also have a monitor output and audio inputs and outputs, providing flexibility for classroom installations. The VPL-CW125, VPL-CX155, and VPL-CX125 models each have a network interface for even more flexibility, enabling presentations and control via a network.

Easy Lamp Replacement and Filter Cleaning (Minimal Maintenance)

 (Fig. 2)

When a lamp needs to be replaced in any of the VPL-C Series projectors, a message will appear on the screen to inform the user. Filter cleaning is recommended at the same time as lamp replacement to greatly reduce the number of maintenance events compared to conventional projectors. The lamp is easily accessible from inside the rear cover, while the filter can be reached from the front of the projector. This means that lamp replacement and filter cleaning can be performed without uninstalling the projector.

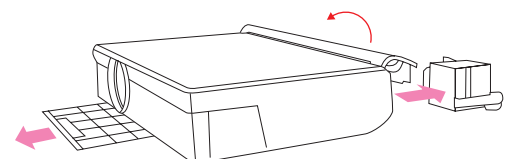

Fig. 2 Easy Lamp Replacement and Filter Cleaning

ID Function for Multi-Projector Installation

VPL-CW125 VPL-CX155 VPL-CX125

With a built-in ID function, the VPL-C Series of projectors can be controlled independently using a single Remote Commander unit. For multi-projector installations in a single room, this feature is indispensable during both installation and operation.

Vertical and Horizontal Digital Keystone Correction

Both vertical digital keystone correction and the Side Shot³ (horizontal keystone correction) functions are available on the VPL-C Series of projectors. These allow images to be projected with their correct geometry when space is limited or when the projector is placed off-axis from the center of the screen.

³ The Side Shot function is available on the VPL-CW125, VPL-CX155, and VPL-CX125 only.

Maintenance via Network

VPL-CW125 VPL-CX155 VPL-CX125

A number of functions on the VPL-CW125, VPL-CX155, and VPL-CX125 can be performed remotely via a web browser.⁴ For example, the projector's current status can be verified and simple controls can be performed, such as powering the unit on or off. Also, the system can be set up to send automatic e-mail reports to designated recipients for scheduled maintenance, including projected lamp life and error reports.

⁴ Internet Explorer 5.0 or higher is required.

Quiet and Efficient Operation

Thanks to a new and unique Sony cooling system, the VPL-C Series operates with a very low fan noise, allowing audiences to concentrate on the speaker during presentations. The efficient cooling system minimizes cabinet/exhaust air temperatures and dust ingress, which ultimately improves reliability.

High Security (Control Panel Key Lock, Password Authentication System, Security Bar, and Kensington Lock)

Both a control panel key lock and a password authentication system are available to help prevent unauthorized use of the VPL-C Series projectors. A built-in security bar or Kensington™ lock can also be used to help prevent theft.

Useful Remote Commander Units

Multi-Function Remote (Fig. 3)

VPL-CW125 VPL-CX155 VPL-CX125

The supplied Remote Commander unit for the VPL-CW125, VPL-CX155, and VPL-CX125 is useful for both setting up the projector during installation and changing settings for a presentation. This unit has buttons for direct input selection, so users do not have to toggle through the entire range of inputs to select the desired one. With the projector ID function, each projector in a multiple-projector installation can be controlled independently from a single remote.

Compact Card-Type Remote (Fig. 4)

VPL-CX150 VPL-CX120 VPL-CX100

For simple operation, the VPL-CX150, VPL-CX120, and VPL-CX100 are supplied with a card-type Remote Commander unit that can be used to adjust projector settings such as digital zoom and audio volume or to activate APA, picture muting, and picture freeze functions.



Fig. 4 Card-Type Remote



Fig. 3 Multi-Function Remote (not to scale)

Network Presentations

VPL-CW125

VPL-CX155

VPL-CX125

When the VPL-CW125, VPL-CX155, or the VPL-CX125 projectors are installed on a LAN, presentations can be projected from any networked PC⁵ – whether connected via a LAN cable or wirelessly. Switching from presenter to presenter is as easy as clicking a mouse – there's no fussing with cables.

⁵ Requires supplied application software to be installed on the PC.

High-speed Image Transfer over IP Networks

Because these projectors employ efficient compression and transmission techniques, they can receive and project images via IP networks for effective presentations from any networked PC. In fact, they can even handle animated Microsoft® PowerPoint® presentations.

Network Presentations Using up To Five Projectors

Up to five projectors can be connected to a network, and the image from a single PC can be projected by each of them. This feature is ideal for both large venues and multiple rooms in which images have to be projected from various locations.

Network Presentations Almost Anywhere

By manually registering a PC's IP address to these projectors, images can be projected not only across the country, but across the globe. This is ideal for applications such as distance learning and long-distance corporate communication.

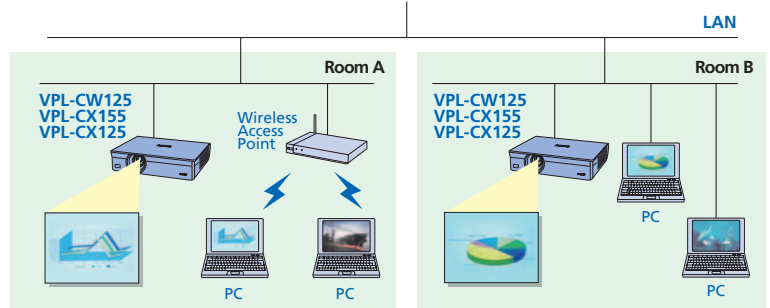

Network Presentation System Diagram

System Requirements to Run Supplied Application Software	
Hardware	Minimum CPU Requirements: Intel® Pentium® III 600-MHz or CPU recommended for use with OS – whichever requirement is higher
	Minimum Memory Requirements: 64 MB or amount of memory recommended for use with OS – whichever requirement is higher (128 MB or more is recommended)
	Hard Disk: 10 MB or more of free space
	Other Hardware Requirements: Display (XGA recommended), Network Capability, CD-ROM Drive
Operating System	Microsoft Windows® 98 SE / Windows ME / Windows 2000 / Windows XP Home Edition / Windows XP Professional Edition / Windows Vista Home Basic / Windows Vista Home Premium / Windows Vista Ultimate / Windows Vista Business
Browser	Internet Explorer 5.0 or higher

Sony cannot guarantee that the application software will run properly even though all of the above system requirements are met.

Notice Regarding Network Presentations

- When a WXGA or higher resolution image is sent from a computer to the VPL-CW125 projector, the image is processed using 1024 x 768 pixels.
- Animation effects and the slide show function in Microsoft PowerPoint presentations can be used; however, transmission delays may occur if a large number of effects are performed at once or if several slides are turned at once.
- Network transmission is not suitable for video.
- Network transmission should not be used with sound.
- Applications that use DirectX® application programming interface may not be displayed properly.
- When using Windows Vista, Windows XP or Windows 2000 Operating Systems, the user must be logged into an account with computer administrator access.
- Application software is provided in English and Japanese.
- Network presentations may not be possible depending on network environment and available bandwidth.

Other Features

- **Digital Zoom Function (up to 4x)**
- **Image Freeze Function**
- **Smart APA (Auto Pixel Alignment)**
- **Multi Language OSD**
- **Ceiling Mount Design⁶**
- **Direct Power On/Off**
- **Picture/Audio Muting**
- **Low Power Consumption (0.5 W standby power)**

⁶ Requires an optional ceiling mount kit. Please contact your local Sony sales office for details.

PRESET SIGNAL CHART

No.	Preset signal	fH (kHz)	fV (Hz)	Sync
1	Video 60 Hz	15.734	59.940	—
2	Video 50 Hz	15.625	50.000	—
3	480/60i	15.734	59.940	S on G/Y
4	575/50i	15.625	50.000	S on G/Y
5	480/60p	31.470	60.000	S on G/Y
6	575/50p	31.250	50.000	S on G/Y
7	1080/60i	33.750	60.000	S on G/Y
8	1080/50i	28.130	50.000	S on G/Y
10	720/60p	45.000	60.000	S on G/Y
11	720/50p	37.500	50.000	S on G/Y
21	640 x 350	31.469	70.086	H-pos, V-neg
22	VESA 85 (VGA350)	37.861	85.080	H-pos, V-neg
23	640 x 400	24.823	56.416	H-neg, V-neg
24	VGA Mode 2	31.469	70.086	H-neg, V-pos
25	VESA 85 (VGA400)	37.861	85.080	H-neg, V-pos
26	640 x 480	31.469	59.940	H-neg, V-neg
27	Mac 13	35.000	66.667	H-neg, V-neg
28	VESA 72	37.861	72.809	H-neg, V-neg
29	VESA 75 (IBM M3)	37.500	75.000	H-neg V-neg
30	VESA 85	43.269	85.008	H-neg V-neg

No.	Preset signal	fH (kHz)	fV (Hz)	Sync
31	800 x 600	35.156	56.250	H-pos, V-pos
32	VESA 56	37.879	60.317	H-pos, V-pos
33	VESA 60	48.077	72.188	H-pos, V-pos
34	VESA 75 (IBM M5)	46.875	75.000	H-pos, V-pos
35	VESA 85	53.674	85.061	H-pos, V-pos8
36	832 x 624	49.724	74.550	H-neg, V-neg
37	1024 x 768	48.363	60.004	H-neg, V-neg
38	VESA 60	56.476	70.069	H-neg V-neg
39	VESA 75	60.023	75.029	H-pos, V-pos
40	VESA 85	68.677	84.997	H-pos, V-pos
41	1152 x 864	63.995	70.019	H-pos, V-pos
42	VESA 75	67.500	75.000	H-pos, V-pos
43	VESA 85	77.487	85.057	H-pos, V-pos
44	1152 x 900	61.795	65.960	H-neg, V-neg
45	1280 x 960	60.000	60.000	H-pos, V-pos
46	VESA 75	75.000	75.000	H-pos, V-pos
47	1280 x 1024	63.974	60.013	H-pos, V-pos
48	VESA 60	79.976	75.025	H-pos, V-pos
49	SXGA VESA75	91.146	85.024	H-pos, V-pos
50	1400 x 1050	65.317	59.978	H-pos, V-pos
51	SXGA+	65.317	59.978	H-pos, V-pos
55	1280 x 768	47.776	59.870	H-neg, V-pos
56	1280 x 720	44.772	59.855	H-neg, V-pos
60	1360 x 768	44.720	59.799	H-neg, V-pos

Images may not be reproduced correctly when signals other than those listed above are input. Contact your local Sony sales office for more information regarding signals not listed.

THROWING DISTANCE CHART

VPL-CX155 VPL-CX150 VPL-CX125 VPL-CX120 VPL-CX100

Screen size	40	60	80	100	120	150	180	200	250	300
a	min	mm 1170	1770	2380	2990	3590	4510	6020	7540	9050
		(inches) (46 1/8)	(69 3/4)	(93 3/4)	(117 3/4)	(141 3/8)	(177 1/4)	(213 1/8)	(237 1/16)	(297)
max	mm 1350	2050	2750	3450	4140	5190	6240	6940	8680	10430
	(inches) (53 1/4)	(80 3/4)	(108 3/8)	(135 7/8)	(163 1/8)	(204 3/8)	(245 3/4)	(273 3/8)	(341 7/8)	(410 3/4)
b	mm x-237	x-356	x-474	x-593	x-711	x-889	x-1067	x-1185	x-1482	x-1778
	(inches) (x-9 3/8)	(x-14 1/8)	(x-18 3/4)	(x-23 3/8)	(x-28)	(x-35)	(x-42 1/8)	(x-46 3/4)	(x-58 3/8)	(x-70 1/8)
c	mm x-298	x-417	x-535	x-654	x-772	x-950	x-1128	x-1247	x-1543	x-1839
	(inches) (x-11 3/4)	(x-16 1/2)	(x-21 1/8)	(x-25 3/4)	(x-30 1/2)	(x-37 1/2)	(x-44 1/2)	(x-49 1/8)	(x-60 7/8)	(x-72 1/2)

VPL-CW125

Screen size	40	60	80	100	120	150	180	200	250	300	
a	min	mm 1260	1920	2570	3230	3880	4870	5850	6500	8140	9780
	(inches) (49 5/8)	(75 5/8)	(101 1/4)	(127 1/4)	(152 7/8)	(191 7/8)	(230 3/8)	(256)	(320 5/8)	(385 1/8)	
max	mm 1460	2220	2970	3720	4480	5610	6740	7490	9370	11260	
	(inches) (57 1/2)	(87 1/2)	(117)	(146 1/2)	(176 1/2)	(221)	(265 1/2)	(295)	(369)	(443 3/8)	
b	mm x-257	x-385	x-513	x-642	x-770	x-963	x-1155	x-1284	x-1605	x-1925	
	(inches) (x-10 1/8)	(x-15 1/4)	(x-20 1/4)	(x-25 3/8)	(x-30 3/8)	(x-38)	(x-45 1/2)	(x-50 5/8)	(x-63 1/4)	(x-75 7/8)	
c	mm x-318	x-446	x-575	x-703	x-831	x-1024	x-1216	x-1345	x-1666	x-1987	
	(inches) (x-12 5/8)	(x-17 5/8)	(x-22 5/8)	(x-27 3/4)	(x-32 3/4)	(x-40 3/8)	(x-48)	(x-53)	(x-65 5/8)	(x-78 1/4)	

VPL-CX155 VPL-CX150 VPL-CX125 VPL-CX120 VPL-CX100

Screen size	40	60	80	100	120	150	180	200	250	300	
a'	min	mm 1290	1900	2500	3110	3720	4630	5540	6140	7660	9180
	(inches) (50 3/4)	(74 7/8)	(98 1/2)	(122 1/2)	(146 1/2)	(182 3/8)	(218 1/4)	(241 7/8)	(301 5/8)	(361 1/2)	
max	mm 1470	2170	2870	3560	4260	5310	6360	7050	8800	10540	
	(inches) (57 7/8)	(85 1/2)	(113 1/8)	(140 1/4)	(167 3/4)	(209 1/8)	(250 1/2)	(277 5/8)	(346 1/2)	(415 1/8)	
x	mm b+290	b+409	b+527	b+646	b+764	b+942	b+1120	b+1239	b+1535	b+1831	
	(inches) (b+11 1/2)	(b+16 1/8)	(b+20 3/4)	(b+25 1/2)	(b+30 1/2)	(b+37 1/8)	(b+44 1/8)	(b+48 7/8)	(b+60 1/2)	(b+72 1/8)	
b	Free										

VPL-CW125

Screen size	40	60	80	100	120	150	180	200	250	300	
a'	min	mm 1400	2060	2710	3370	4020	5010	5990	6640	8280	9920
	(inches) (55 1/8)	(81 1/8)	(106 3/4)	(132 3/4)	(158 5/16)	(197 3/8)	(235 7/8)	(261 1/2)	(326 1/8)	(390 5/8)	
max	mm 1600	2350	3100	3860	4610	5740	6870	7620	9510	11390	
	(inches) (63)	(92 5/8)	(122 1/8)	(152)	(181 5/8)	(226 1/8)	(270 5/8)	(300 1/8)	(374 1/2)	(448 1/2)	
x	mm b+310	b+438	b+567	b+695	b+823	b+1016	b+1208	b+1337	b+1658	b+1979	
	(inches) (b-12 1/4)	(b-17 3/8)	(b-22 3/8)	(b-27 3/8)	(b-32 1/2)	(b-40)	(b-47 5/8)	(b-52 3/4)	(b-65 3/8)	(b-78)	
b	Free										

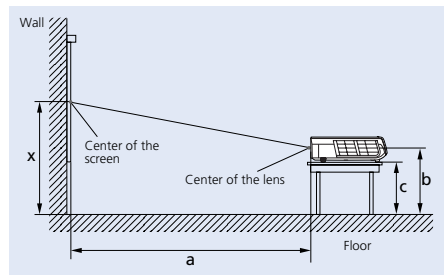

a: distance between the screen and the center of the lens
 b: distance between the floor and the center of the lens
 c: distance between the floor and the bottom of the adjusters of the projector
 x: distance between the floor and the center of the screen (free)

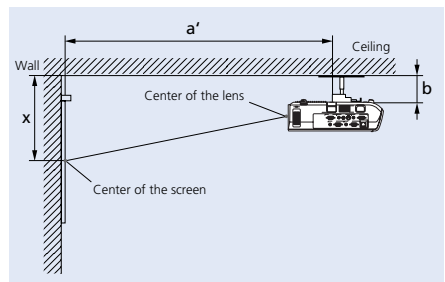

a': distance between the screen and the front mounting hole on the bottom surface of the projector
 b: distance between the ceiling and the projector mounting surface of the suspension support (ceiling mount kit is not supplied)
 x: distance between the ceiling and the center of the screen

Please contact your nearest Sony office for details on installing the VPL-C Series of projectors.

OPTIONAL ACCESSORY



LMP-C200
Projector Lamp (for replacement)

I/O PANEL

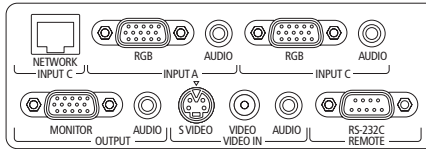

VPL-CW125
VPL-CX155
VPL-CX125

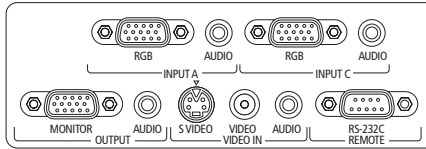

VPL-CX150
VPL-CX120
VPL-CX100

CONTROL PANEL



DIMENSIONS

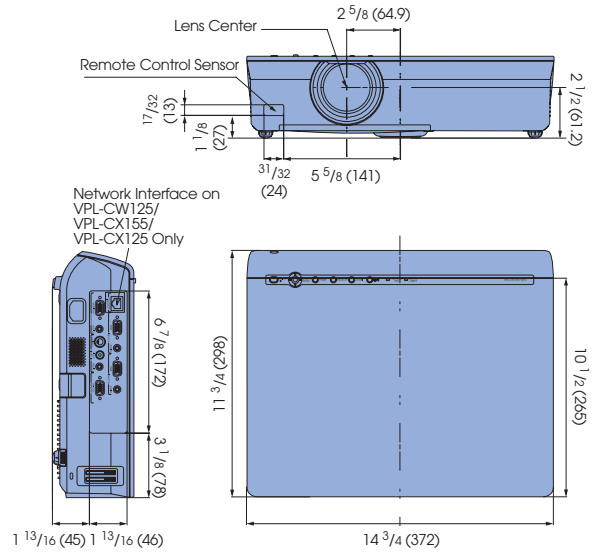

Unit: inches (mm)

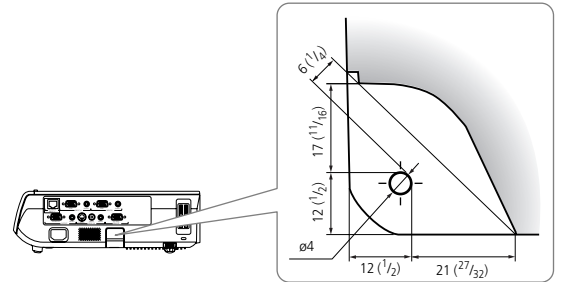

Security Bar Cross Section

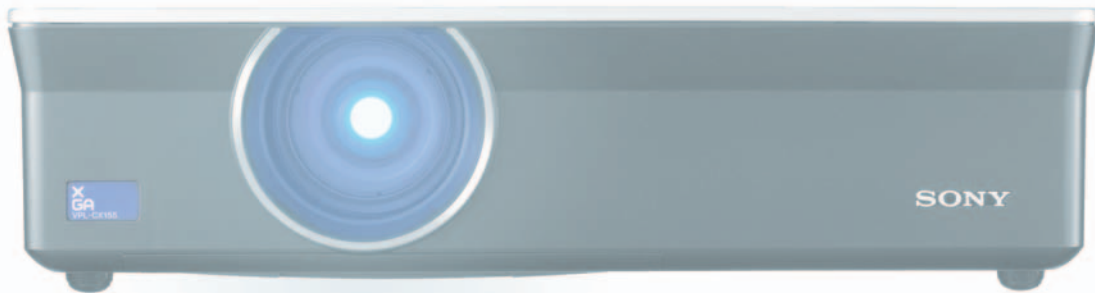

SPECIFICATIONS

	VPL-CW125	VPL-CX155	VPL-CX150	VPL-CX125	VPL-CX120	VPL-CX100
Optical						
Projection system	3 LCD panels, 1 lens projection system					
LCD panel	0.74-inch WXGA panel, 3,278,400 (1366 x 800 x 3) pixels	0.79-inch XGA panel, 2,359,296 (1024 x 768 x 3) pixels				
Projection lens	1.2 times zoom lens, f23.5 to 28.2 mm, F1.75 to 2.17					
Lamp	200W ultra high pressure Lamp					
Screen coverage	40 to 300 inches (measured diagonally)					
Keystone correction range*	Vertical: +/- 25° (max.), Horizontal: +/- 15° (max.)		Vertical: +/- 25° (max.)	Vertical: +/- 25° (max.), Horizontal: +/- 15° (max.)	Vertical: +/- 25° (max.)	
Light output	3000 lumens (lamp mode high), 2200 lumens (lamp mode standard)	3500 lumens (lamp mode high) , 2500 lumens (lamp mode standard)		3000 lumens (lamp mode high) , 2200 lumens (lamp mode standard)		2700 lumens (lamp mode high) , 1900 lumens (lamp mode standard)
Signals						
Color system	NTSC3.58, PAL, SECAM, NTSC4.43, PAL-M, PAL-N, PAL60 (automatically/manually selected)					
Resolution	Video: 750 TV lines, RGB: 1366 x 800 pixels	Video: 750 TV lines, RGB: 1024 x 768 pixels				
Acceptable computer signals	fH : 19 to 92KHz, fV : 48 to 92Hz (Up to SXGA+ (fV 60Hz))					
Acceptable video signals	15k RGB 50/60Hz, Component 50/60Hz, Progressive Component, DTV (480/60i, 575/50i, 480/60p, 575/50p, 720/60p, 720/50p, 1080/60i, 1080/50i), Composite Video, Y/C Video					
Speaker						
	Mono 1 W (max.) x1					
General						
Dimensions (W x H x D)	14 3/4 x 3 5/8 x 11 3/4 inches, (372 x 90 x 298 mm)					
Weight	Approx. 9 lbs 1 oz (4.1 kg)					
Power requirements	AC 100 to 240 V, 2.9 - 1.2 A, 50/60 Hz					
Power consumption	Max. 285 W, Standby 7 W, Standby (low) 0.5 W					
Heat dissipation	973 BTU					
Operating temperature	32 to 95 °F (0 to 35 °C)					
Operating humidity	35 to 85% (no condensation)					
Storage temperature	-4 to 140 °F (-20 to 60 °C)					
Storage humidity	10 to 90%					
Inputs/Outputs						
VIDEO IN						
Video	Composite Video (RCA phono jack)					
S Video	Y/C Mini DIN 4-pin					
Audio	Stereo mini jack					
INPUT A						
Analog RGB / Component	HD D-sub 15-pin (female)					
Audio	Stereo mini jack					
INPUT B						
Analog RGB	HD D-sub 15-pin (female)					
Audio	Stereo mini jack					
INPUT C						
Network	RJ45: 100BASE-TX/10BASE-T	-	RJ45: 100BASE-TX/ 10BASE-T	-		
OUTPUT						
Monitor out	HD D-sub 15pin					
Audio	Stereo mini jack (variable out)					
REMOTE	RS-232C: D-sub 9 pin (female)					
Supplied accessories						
	Remote Commander Unit	Remote Commander Unit (Card type)	Remote Commander Unit	Remote Commander Unit (Card type)		
	Size AA (R6) batteries (x2)	Lithium battery CR2025 (x1)	Size AA (R6) batteries (x2)	Lithium battery CR2025 (x1)		
	Lens cap					
	HD D-sub 15 pin cable (2m)					
	AC power cord					
	Operating Instructions and Application Software (CD-ROM)					
	Quick Reference Manual					
	Safety Regulations					
	Security Label					
	Warranty Card					

* Horizontal and vertical keystone correction ranges are dependent on one another. Maximum keystone correction may vary with input signal.



- Halogenated flame retardants are not used in cabinets or printed wiring boards.
- Standby power consumption: 0.5 W.
- Corrugated cardboard is used for the packaging cushions.

SONY

Sony Electronics Inc.
One Sony Drive • Park Ridge, NJ 07656
sony.com/projectors

DI-0118A
MK10402V1

© 2007 Sony Electronics Inc. All rights reserved.
Reproduction in whole or in part without written permission is prohibited.
Features and specifications are subject to change without notice.
All non-metric weights and measurements are approximate.
Sony, Remote Commander and Side Shot are trademarks of Sony.
Kensington is a trademark of Kensington Technology Group.
Microsoft and Powerpoint are trademarks of Microsoft.

Printed in U.S.A. 6/07